

---



## CONTENTS

SAFETY .....	2
GETTING STARTED .....	3
INTRODUCTION.....	4
APPLICATION .....	5
OPERATION.....	7
TEST EXAMPLES .....	12
SPECIFICATION.....	18

---

## SAFETY

### Read this manual completely before using the instrument.

1. The TESTEL 100E is designed to behave like an exchange line therefore only telecommunication apparatus designed to connect to telephone lines must be connected to it.
2. **Under no circumstances** must the TESTEL 100E be connected to the Public Switched Telephone Network (PSTN) or any PABX extension ports.
3. When using the TESTEL 100E to test the performance of unapproved telecommunication apparatus, due consideration must be paid to any hazard involved.
4.  **WARNING** The connection sockets have high voltages present during Ringing and Pulse dialling. Although this is not hazardous, it can be painful.  

5. The unit is designed to be powered from a 230 V, 50 Hz source. The IEC Power Lead provided is fitted with a 5 Amp fused mains plug.
6. The Mains Switch at the IEC Socket needs to be in the Off position to isolate the unit from the mains.
7. There are no user serviceable parts in this unit. Under no circumstances should the user attempt to open the unit. If opened, the warranty will be invalidated.
8. Your Crucible Technologies product is guaranteed for one year from the date of purchase. Please keep your invoice as proof of purchase.

Should a problem arise with the product, please contact;  
[tech@crucible-technologies.co.uk](mailto:tech@crucible-technologies.co.uk) for technical assistance.

If you wish to return your product please contact;  
[returns@crucible-technologies.co.uk](mailto:returns@crucible-technologies.co.uk) to receive a returns authorisation number, and instructions for returning the product.

You will be advised of costs prior to any work commencing.

This guarantee does not affect your statutory rights..

---

## GETTING STARTED

Before using the TESTEL 100E, please check that the following items have been included in the shipment:

- TESTEL 100E Unit
- IEC Power Lead
- 2 x RJ11 Converters
- User Manual

Check for damage in transit. If there is any sign of damage, please report it to your supplier and do not attempt to repair the unit.

The unit is factory set to be powered from a 230 V supply. This is indicated on the rating plate. (If a 110 V unit has been supplied, the rating plate will indicate this). Please ensure that this product is powered from the correct source. The apparatus is CLASS II double insulated construction, so does not require a protective earth connection.

**UNDER NO CIRCUMSTANCES SHOULD THIS PRODUCT BE CONNECTED TO THE PSTN**

---

## INTRODUCTION

The TESTEL 100E is designed to help in the testing of a wide range of telecommunication apparatus. Its features make it an invaluable tool in design laboratories, service centres and small-scale production facilities.

The TESTEL 100E provides an accurate simulation of telephone lines. The feed voltage applied to the Unit Under Test (UUT) is 48 V and the ring voltage is 80 V, 25 Hz near sinusoid signal with DC backing. This ensures that telecommunication apparatus that work on the TESTEL 100E are sure to work on real telephone lines.

It is useful for engineers who need to test products. However, the controls are straightforward to use which makes it ideal for non-technical personnel.

---

## **APPLICATION**

There are a wide variety of applications for TESTEL 100E, some of which are listed below:

### **FAULT ANALYSIS**

The TESTEL 100E is useful for checking returns from customers to make sure the fault lies with the returned product and not with the user. Non-technical staff are able to check a telephone, answering machine or fax, just by connecting it to the TESTEL 100E and carrying out tests, as one would do if using a normal phone line. In less than a minute, tests such as Off-hook, dialling, handset operation and ringing can be completed.

The TESTEL 100E provides many benefits over using a telephone line for testing. All the dialled digits can be checked and not just the digits needed to route a call. One person can carry out complete testing as ringing starts at the push of a button. No call costs are involved.

### **REPAIR**

The TESTEL 100E provides a telephone line on every technician's workbench. This allows products to be checked as repairs are carried out. On completion of the repair, the telephone apparatus can be fully checked including operation with both polarity and line current.

### **PRODUCTION**

The TESTEL 100E can be used for production testing of many telecommunication products. Features such as digit timings, signal level (displayed on the bar graph) and adjustable ring level, will allow the test engineer to build the TESTEL 100E into a production test procedure.

---

## OPERATION

### SUPPLY

The unit is designed to be powered from the mains 230 V, 50 Hz using the IEC lead supplied. Connect to the IEC socket at the rear of the unit and switch on. The Power LED will light signifying that power is being supplied to the unit.

### MASTER SOCKET

When the unit plugged into the Master Socket (referred to as Master) seizes the line, the Line Looped LED comes on. If ringing was present, this is stopped. The ring trip operates during the quiet periods of the cadence. There is no ring trip when the continuous ring option is chosen. The polarity and current applied to the Master is dependent on the relevant switch positions. If there is any speech or tone on the line its level is displayed on the bar graph.

When positive polarity is selected A is positive with respect to B. This is reversed when the negative polarity is selected. The S terminal is connected to the B terminal through a 1.8  $\mu$ F capacitor. The E terminal is used for detecting the Earth Recall signal.

The pin configuration on the socket is representative of a standard phone socket on the wall and is as follows:

<b>A</b>	$\Rightarrow$	Pin 2
<b>B</b>	$\Rightarrow$	Pin 5
<b>E</b>	$\Rightarrow$	Pin 3
<b>S</b>	$\Rightarrow$	Pin 4

**NOTE:** There are also four 4mm sockets supplied, connected to A, B, E and S. These are useful for connection of measurement apparatus or adaptors.

## **RINGING**

The user can select the cadence and level of the ringing. A PSTN or PBX type cadence can be selected. Alternatively, the ringing can be applied continuously. The level can be set to High or Low or to a user pre-selected one. This is done by adjusting a multi-turn pot at the rear of the unit, until the required level is obtained. Once selected, the ringing can be applied to the Master by operating the Start/Stop button.

The ringing is terminated, either by the Master seizing the line or by operating the Start/Stop button. The same ringing cadence and level is applied to the Extension when the Master dials 159. In this case, the ringing stops either when the Extension seizes the line or when the Master goes On-hook. No ring trip is provided on continuous ring option.

When the Extension is rung by keying in 159, Ring Back tone at the selected cadence is fed back to the unit plugged into the Master socket. The Extension can dial the Master by dialling 159.

## **DIALLING**

The digits dialled by the UUT are shown on the 8 digit LCD. The digits can be Pulse, Tone or both; the Tone digits are shown with a dot underneath to differentiate them from the Pulse digits. The timing limit on the Make and Break of Pulse dialling are set carefully, to detect any problem that may exist. The level of tones is displayed on the Bar Graph.

A Timed Break Recall (TBR) signal is either displayed as a Pulse digit 1 or R depending on its timing. If the break time is less than 80 mS then a Pulse digit 1 is displayed. If break is greater than 80 mS then an R is displayed. This way the time limits for Pulse break are not compromised. An Earth Recall is shown as an E on the LCD display.

---

When more than 8 digits are dialled and there is a pause of more than 5 seconds the display starts to scroll all the digits dialled. A maximum of 64 digits can be detected and displayed.

When the UUT is On-line, pressing the Start/Stop button can freeze the scrolling display. In the frozen mode the display flashes. The freeze can be terminated by the operation of the Start/Stop button or by dialling a digit. (Note: The display freeze only works in the On-line mode, as in the Off-line mode, the Start/Stop button is used to start the ringing). The scrolling of the display carries on in the Off-line mode.

### **BAR GRAPH**

This displays the level of signals (tone or speech) at the Master socket interface. For signals generated by the TESTEL 100E or the Extension, the Bar Graph will be affected by the Attenuator Switch position, for example it will give the true level at the Master. For signals generated by the Master (eg speech/tones) the level displayed is not affected by the Attenuator. However, the Attenuator affects the level presented to the TESTEL 100E or to the Extension.

### **ATTENUATOR**

This is used to attenuate signals to and from the Master. When the Extension is On-hook then the Attenuator controls the level of test tones applied to the Master. Also tone signals originating from the Master are controlled by the Attenuator before being detected. When the Extension is Off-hook signals between it and the Master are affected by the Attenuator position.

### **EXTENSION SOCKET**

The Extension can be rung from the Master by dialling 159 (Pulse, Tone or mixed). The parameters of the ringing applied are as set on the ring control section. The ringing stops either when the Extension comes Off-hook or the Master goes On-hook.



---

The Attenuator Switch controls the attenuation to speech or signals between the Master and Extension. This can be set to 0, 10 or 30 dB of attenuation. Whenever the Extension seizes the line a speech path is set up between it and the Master.

NOTE: There are two 4mm sockets supplied connected to A and B. These are useful for connection of measurement apparatus or adapters.

## PULSE DIAL TIMINGS

Pulse dial Make/Break/IDP timings can be brought up on the display by dialling 200 after seizing the line. The displayed Make/Break timings are based on the last digit dialled and the IDP based on the last two digits dialled. Further digits (Pulse or Tone) can be timed by dialling these after 200. The display will automatically update to show the Make/Break timings of the last digit dialled and the IDP between the last two digits.

## TONE DIAL TIMINGS

Tone dialling On/Off times can be displayed by entering 200 after seizing the line. On timings are based on the last digit dialled whilst Off timings are based on the pause between last two digits dialled. Further digits (Pulse or Tone) can be timed by entering these after dialling 200.

## PULSE DIAL TIMING CHECK

During Pulse dialling, if the following timing errors are detected, an error message is flashed on the display.

<b>MAKE TIMINGS</b>	Limits $33.3 \text{ mS} \pm 30\%$	
	Low timing gives an error	MKE<23 mS
	High timing gives an error	MKE>43 mS
<b>BREAK TIMINGS</b>	Limits $66.6 \text{ mS} \pm 30\%$	
	Low timing gives an error	MKE<46 mS
	High timing gives an error	MKE>86 mS

Transients of less than 5 mS duration are ignored.

The error message will time out after 5 seconds. However, if a valid digit is detected or another error message is to be displayed, the original message will be overwritten.

---

**DIAL UP SUPERVISORY TONES**

Various supervisory tones can be dialled up by keying in specific codes from the unit plugged into the Master socket. These are given below:

- 300** ⇒ RING BACK TONE
- 301** ⇒ PAY TONE
- 302** ⇒ ENGAGED TONE
- 303** ⇒ PATH ENGAGED (PARK) TONE
- 304** ⇒ NUMBER UNOBTAINABLE
- 147** ⇒ RING BACK

NOTE 1: The frequency for all the above tones is set to 425 Hz

NOTE 2: A couple of self-test features are provided.

- 100** ⇒ GIVES ISSUE OF SOFTWARE
- 999** ⇒ TESTS LCD

**TEST EXAMPLES**

**FUNCTIONAL TEST OF TELEPHONES**

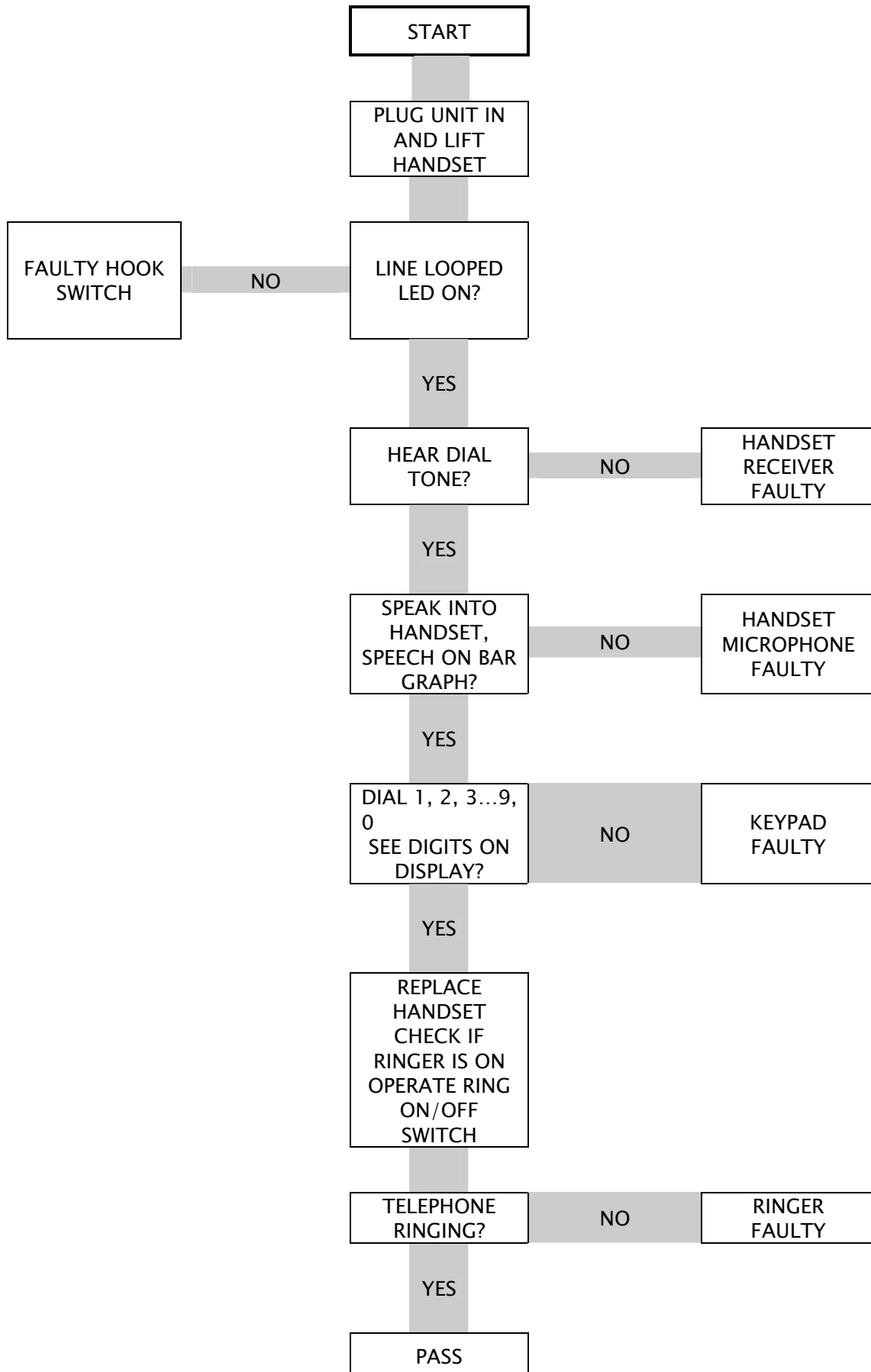

RING DETECT SENSITIVITY ON AUTO-ANSWER APPARATUS

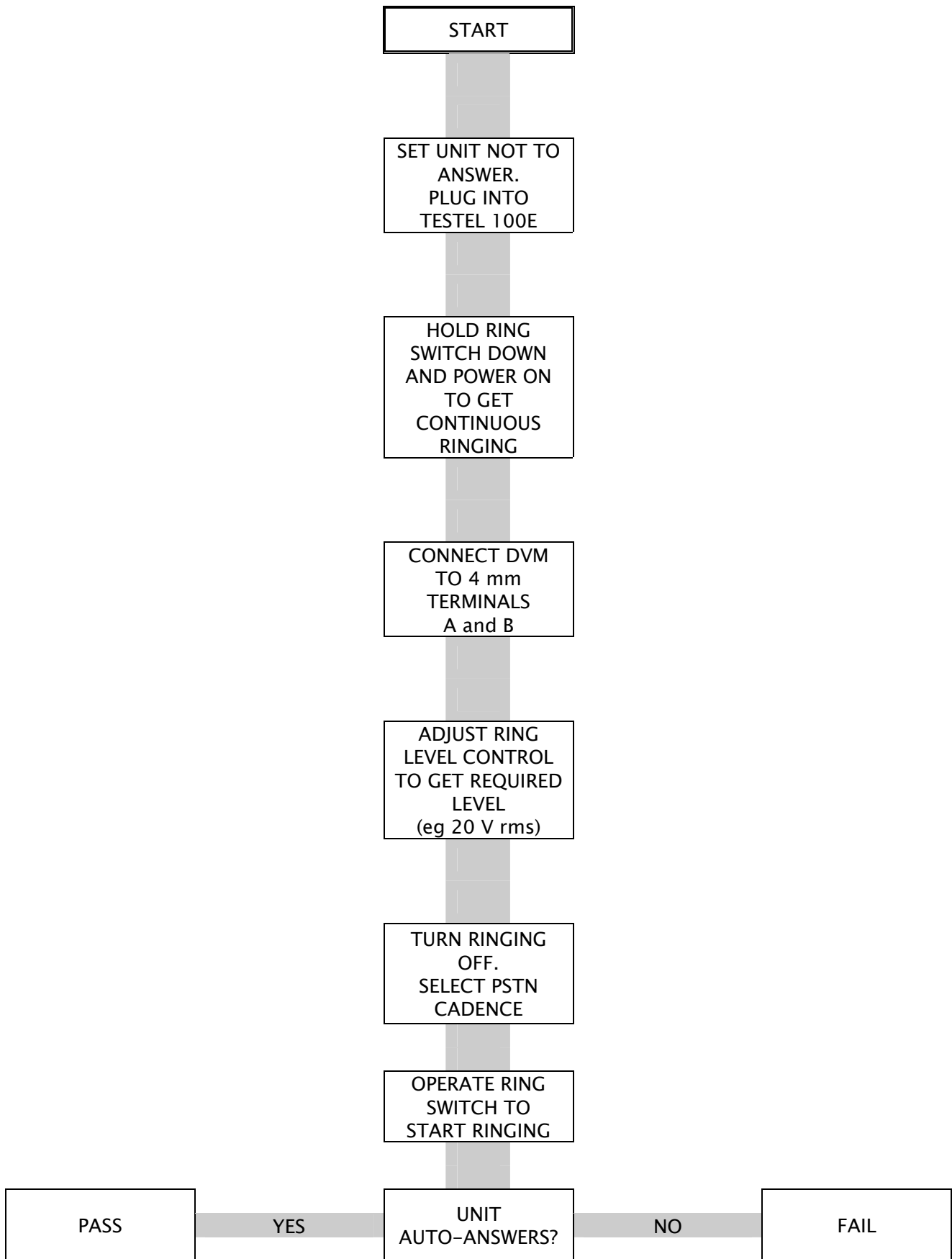

**ANSWERING MACHINE CLEARDOWN TO SILENCE**

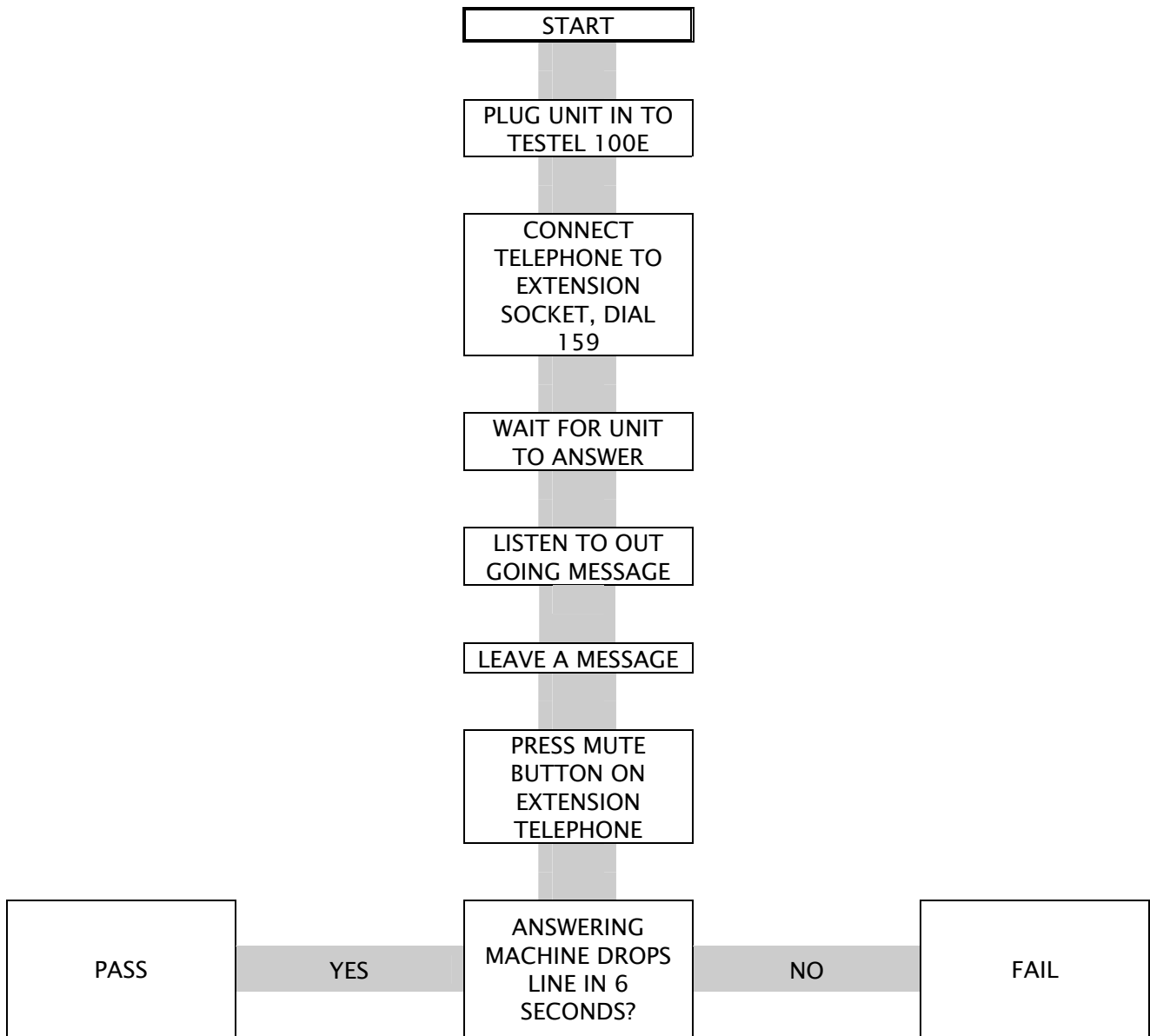

**ANSWERING MACHINE CLEARDOWN TO EXTENSION PHONE PICK UP**

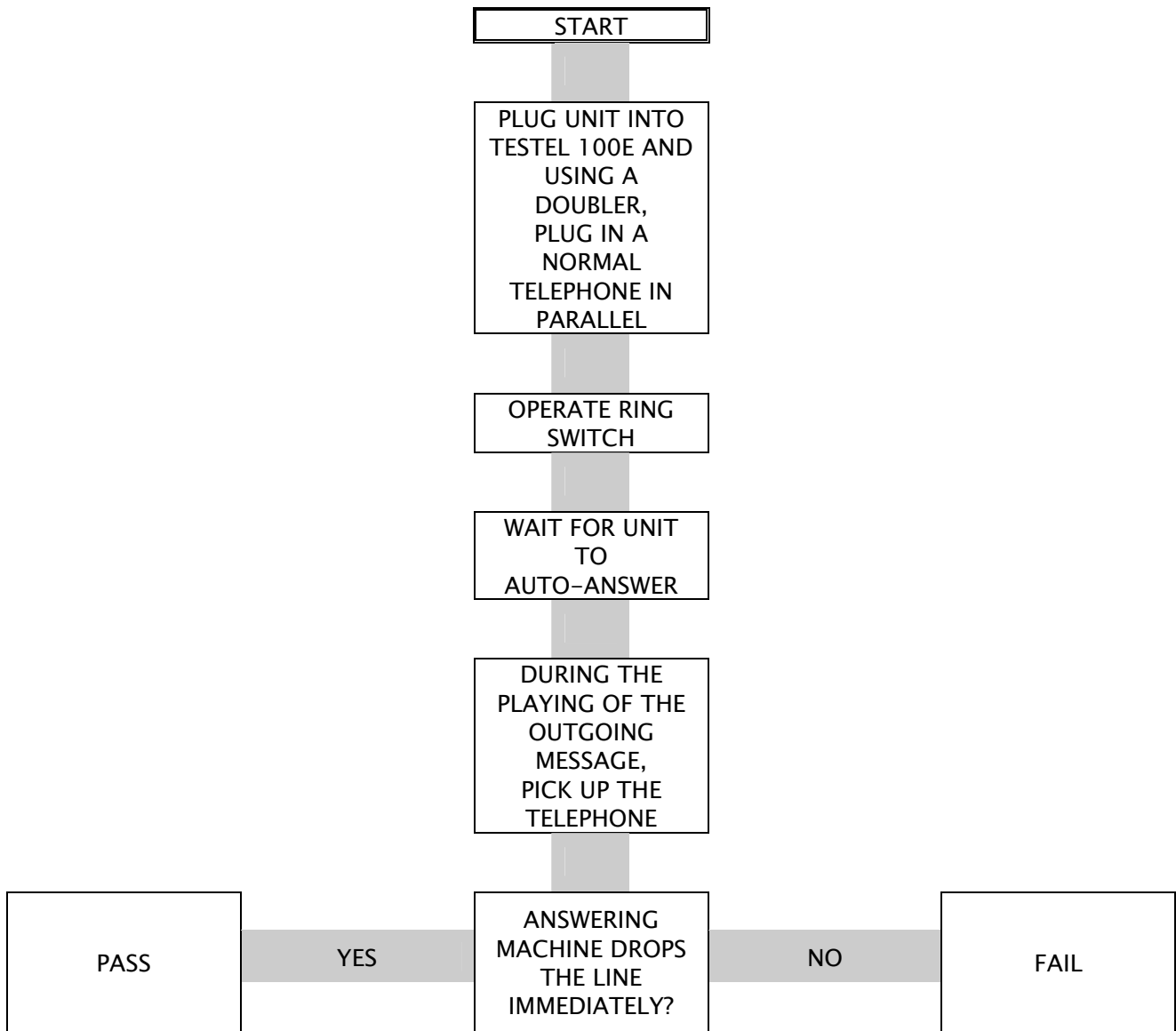

**ANSWERING MACHINE REMOTE INTERROGATION**

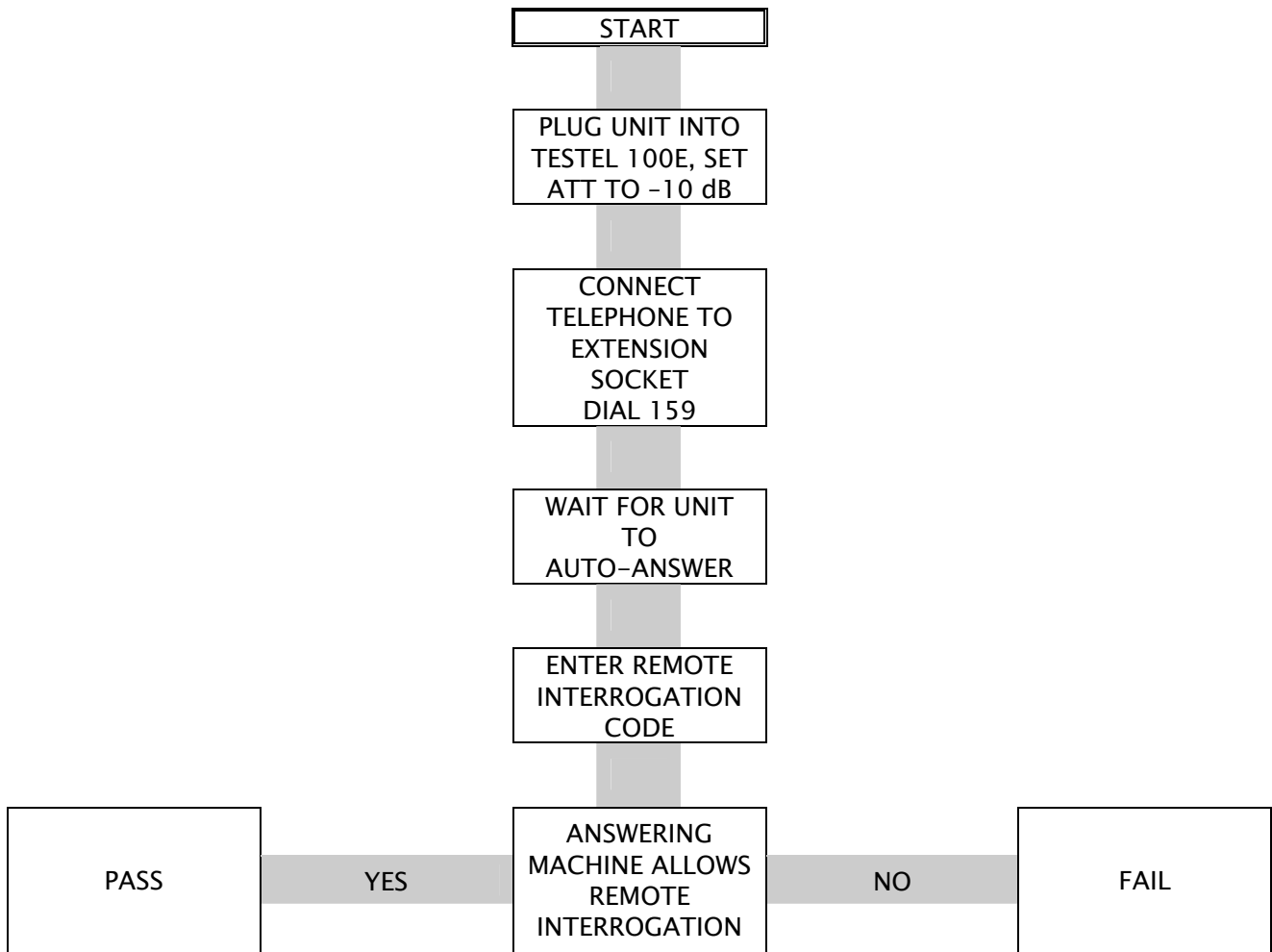



**MODEM TEST**

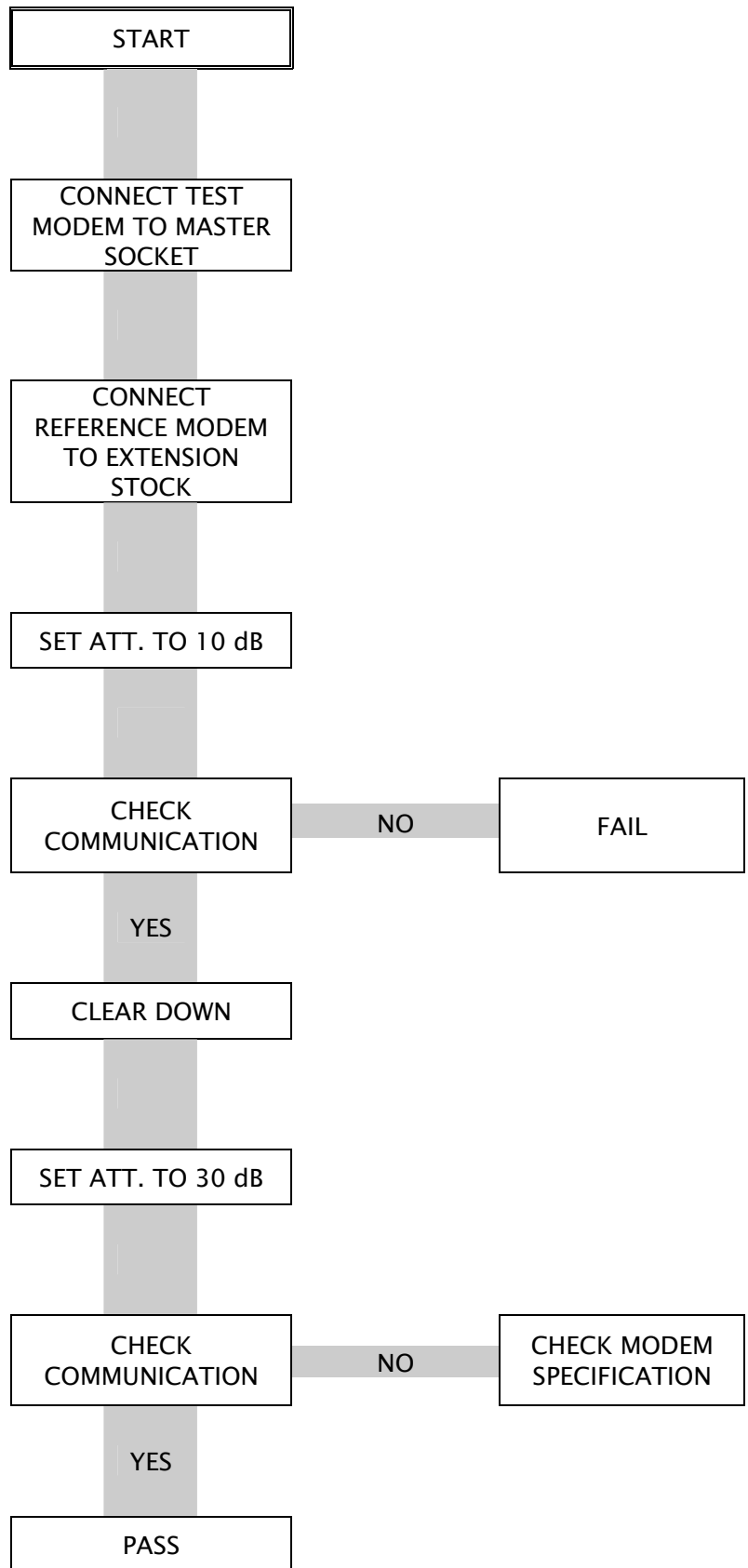

**SPECIFICATION**

MASTER SOCKET	DC Voltage	48 V $\pm$ 5%
	Feed Bridge	2 x 200 $\Omega$ $\pm$ 5%
	DC Resistance	180 $\Omega$ $\pm$ 10% (= 1 km line)
1380 $\Omega$ $\pm$ 10% (= 7.5 km line)		
EXTENSION SOCKET	Voltage	48 V $\pm$ 5%.
	S/C Current	40 mA $\pm$ 10%.
DIAL TONE	Frequency	425 Hz
	Level:	-6, -16 or -36 dBm
RINGING	Voltage High	80 V $\pm$ 10% rms
	Voltage Low	40 V $\pm$ 10% rms
	User Level	Adjustable from 0 V to 95 V rms
	Frequency	25 Hz
	Type	AC (near sinusoid), DC backed
	Cadence	PSTN, PBX or Continuous
PULSE DIALLING	Make	25-41 mS
	Break	50-82 mS
	IDP	>200 mS
	On-Hook	>300 mS
	Off-Hook	>200 mS
	TBR	80-110 mS
TONE DIALLING	Tone Time	>40 mS
	Accept Frequency	$\pm$ 1.5%
	Reject Frequency	$\pm$ 3.5%
ATTENUATION		To and from Master Socket 0, 10 or 30 dB
BAR GRAPH	Reference	Top LED centred on -1 dBm $\pm$ 1 dB
		Ten LEDs each 3 dB $\pm$ 1 dB
	Attenuation Range	0 to 30 dB
TOLERANCE unless otherwise specified	Frequency	$\pm$ 10%
	Timing	$\pm$ 10%
	Level	$\pm$ 3 dB
POWER	Mains	230 V, 50 Hz, 50 mA